

YELLOW MV53164
HIGH EFFICIENCY GREEN MV54164
HIGH EFFICIENCY RED MV57164

PACKAGE DIMENSIONS

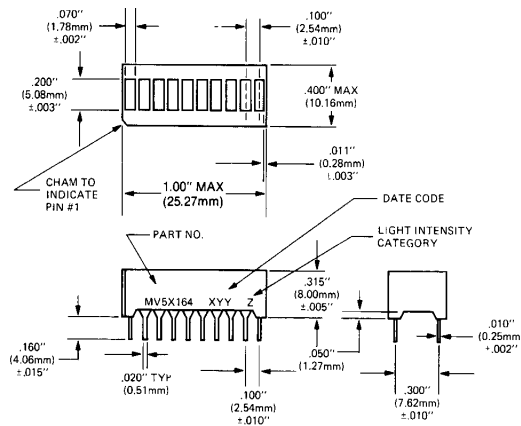

NOTE: TOLERANCES $\pm .010"$ UNLESS SPECIFIED

DESCRIPTION

The MV5X164 series is a 10 segment bargraph display with separate anodes and cathodes for each light segment. The packages are end-stackable.

FEATURES

- Large segments, closely spaced
- End-stackable
- Fast switching—excellent for multiplexing
- Low power consumption
- Directly compatible with IC's
- Wide viewing angle
- Standard .3-inch DIP lead spacing
- Categorized for Luminous Intensity (See Note 1)

C1468A

ABSOLUTE MAXIMUM RATINGS

	MV53164	MV54164	MV57164
Power dissipation at 25°C ambient	750 mW	750 mW	750 mW
Derate linearly from 50°C	-14.3 mW/°C	-14.3 mW/°C	-14.3 mW/°C
Storage and operating temperature	-40°C to +85°C	-40°C to +85°C	-40°C to +85°C
Continuous forward current			
Total	200 mA	300 mA	300 mA
Per segment	25 mA	30 mA	30 mA
Reverse voltage			
Per segment	6.0 V	6.0 V	6.0 V
Soldering time at 260°C (See Notes 3 and 5)	5 sec.	5 sec.	5 sec.

TYPICAL THERMAL CHARACTERISTICS

	MV53164	MV54164	MV57164
Thermal resistance junction to free air Φ_{JA}	160°C/W	160°C/W	160°C/W
Wavelength temperature coefficient (case temp.)	1.0 A/°C	1.0 A/°C	1.0 A/°C
Forward voltage temperature coefficient	-1.5 mV/°C	-1.4 mV/°C	-2.0 mV/°C

ELECTRO-OPTICAL CHARACTERISTICS (25°C Free Air Temperature Unless Otherwise Specified)						
	MIN.	TYP.	MAX.	UNITS	TEST CONDITIONS	
Forward voltage MV53164, MV57164/MV54164		2.0/2.2	2.5/3.0	V	$I_F=10\text{ mA}$	
Luminous Intensity (unit average) (See Note 1)	510	1800		μcd	$I_F=10\text{ mA}$	
Pulsed Luminous Intensity (MV54164)	710	2500		μcd	$I_F=60\text{ mA}$ peak; 1:6 DF	
Peak emission wavelength						
MV53164		585		nm		
MV54164		562		nm		
MV57164		630		nm		
Spectral line half width MV53164, MV57164/MV54164		40/30		nm		
Dynamic resistance						
Segment MV53164, MV57164/MV54164		26/12		Ω	$I_F=20\text{ mA}$	
Capacitance MV53164, MV57164/MV54164		35/40		pF	$V=0, f=1\text{ MHz}$	
Switching time		500		ns	$I_F=10\text{ mA}$	
Reverse voltage	6.0				$I_R=100\mu\text{A}$	

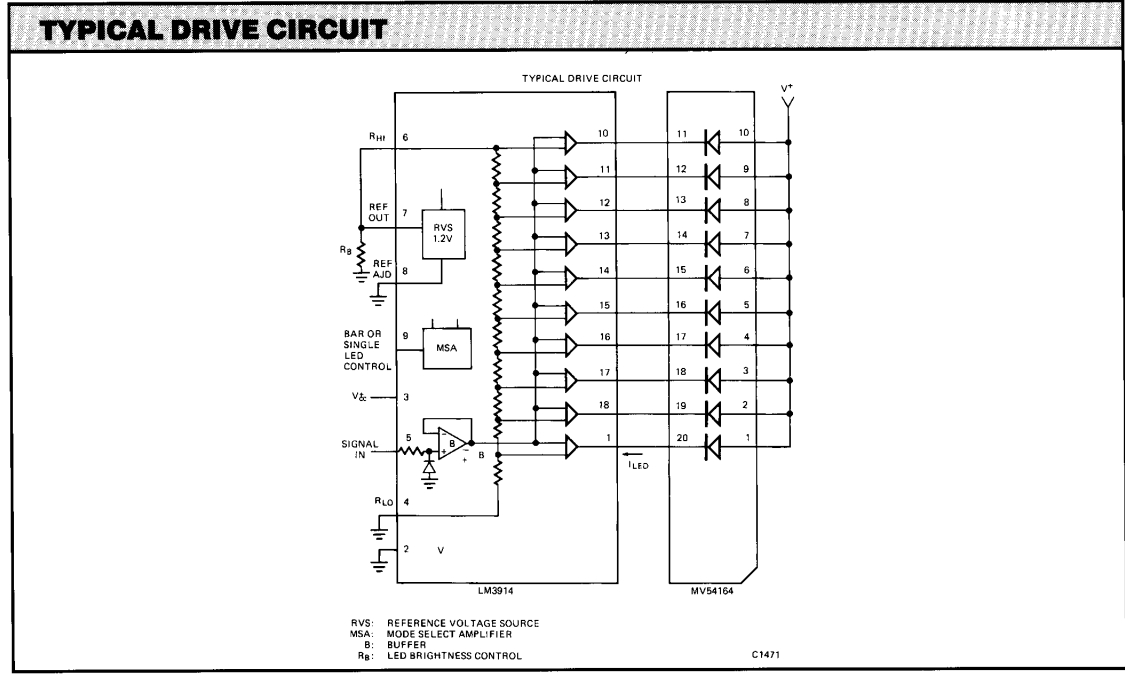

PIN CONNECTIONS							
PIN NO.	ELECTRICAL CONNECTIONS	PIN NO.	ELECTRICAL CONNECTIONS	PIN NO.	ELECTRICAL CONNECTIONS	PIN NO.	ELECTRICAL CONNECTIONS
1	Bar 1 Anode	6	Bar 6 Anode	11	Bar 10 Cathode	16	Bar 5 Cathode
2	Bar 2 Anode	7	Bar 7 Anode	12	Bar 9 Cathode	17	Bar 4 Cathode
3	Bar 3 Anode	8	Bar 8 Anode	13	Bar 8 Cathode	18	Bar 3 Cathode
4	Bar 4 Anode	9	Bar 9 Anode	14	Bar 7 Cathode	19	Bar 2 Cathode
5	Bar 5 Anode	10	Bar 10 Anode	15	Bar 6 Cathode	20	Bar 1 Cathode

TYPICAL CURVES MV53164 MV54164 MV57164 (PER SEGMENT) (25°C Free Air Temperature)

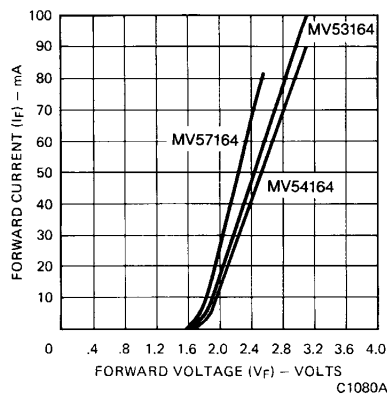

Fig. 1. Forward Current vs. Forward Voltage

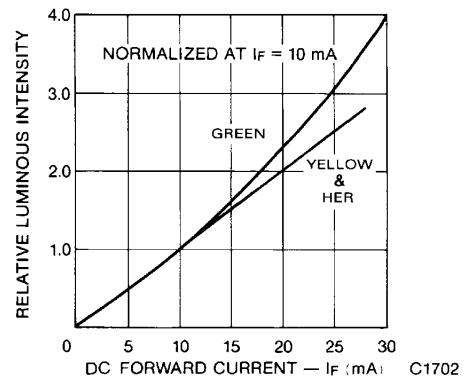

Fig. 2. Relative Luminous Intensity vs. DC Forward Current (Both LED Chips ON)

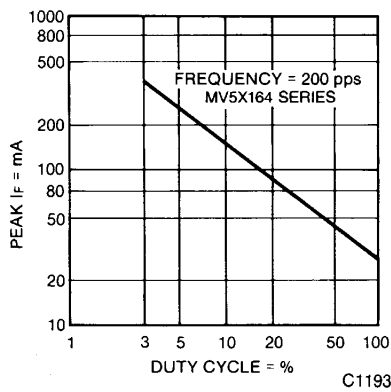

Fig. 3. Max Peak Current vs. Duty Cycle

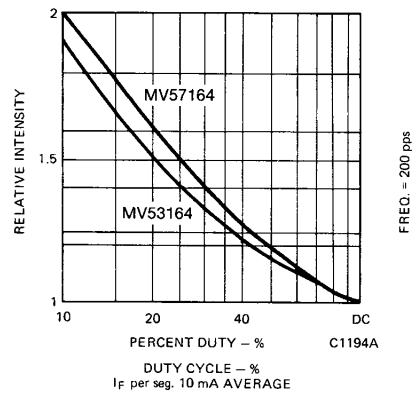

Fig. 4. Luminous Intensity vs. Duty Cycle

TYPICAL CURVES MV53164 MV54164 MV57164 (PER SEGMENT) (25°C Free Air Temperature) (Cont'd)

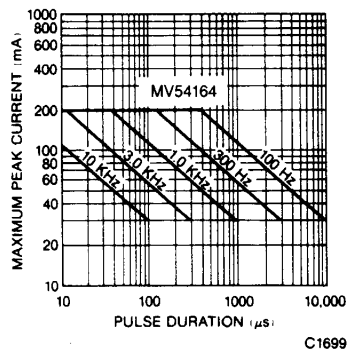

Fig. 5. Maximum Peak Current vs. Pulse Duration

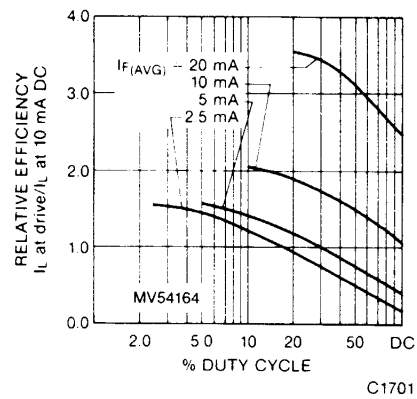

Fig. 6. Relative Efficiency vs. Duty Cycle

FILTER RECOMMENDATIONS

For optimum ON and OFF contrast, one of the following filters or equivalents may be used over the lamp:

MV53164
Panelgraphic Yellow 25 or Amber 23
Homalite 190—1720 or 100—1726

MV54164
Panelgraphic Green 48
Homalite 100—1440 Green

MV57164
Panelgraphic Red 60
Homalite 100—1605

In situations of high ambient light, a neutral density filter can be used to achieve greater contrast:

Panelgraphic Grey 10

Panelgraphic Grey 10
Homalite 100—1266 Grey

NOTES

1. The average Luminous Intensity is obtained by summing the Luminous Intensity of each segment and dividing by the total number of segments. The standard of measurement is the Photo Research Corp. "Spectra" Microcandela Meter (Model IV-D) corrected for wavelength. Intensity will not vary more than $\pm 33.3\%$ between all segments within a unit.
2. Leads immersed to 1/16 inch (1.6 mm) from the body of the device. Maximum unit surface temperature is 140°C.
3. All units are categorized for Luminous Intensity. The Intensity category is marked on each part as a suffix letter to the part number.
4. For flux removal, Freon TF, Freon TE, Isoproponal or water may be used to their boiling points.